

## Pribor

## Zaštitni poklopac

## 1-polni zaštitni poklopac za osnovu osigurača

tip	šifra	težina [g]	pakiranje [kom]
D01V, D01N	002251006	8	50/700
D02V, D02N	002251005	8	50/700

## 3-polni zaštitni poklopac za osnovu osigurača

tip	šifra	težina [g]	pakiranje [kom]
D01V/3, D01N/3	002251004	17	14/280
D02V/3, D02N/3	002251002	16	14/280



## Kalibarski prsten

## V D01 za osnovu E 14

I <sub>n</sub> [A]	boja	šifra	težina [g]	pakiranje [kom]
2	ružičasta	002241001	1	50/500
4	smeđa	002241002	1	50/500
6	zelena	002241003	1	50/500
10	crvena	002241004	1	50/500

## V D02 za osnovu E 18

I <sub>n</sub> [A]	boja	šifra	težina [g]	pakiranje [kom]
2*	ružičasta	002243001	1	50/500
4*	smeđa	002243002	1	50/500
6*	zelena	002243003	1	50/500
10*	crvena	002243004	1	50/500
16*	siva	002243005	1	50/500
20	plava	002242001	1	50/500
25	žuta	002242002	1	50/500
35	crna	002242003	1	50/500
50	bijela	002242004	1	50/500

\* Za upotrebu rastalnih uložaka D01 i osnova osigurača D02.



**Ključ za namještanje**

šifra	težina [g]	pakiranje [kom]
002241000	17	20/120

**Kapa D0****Kapa D0**

tip	šifra	navoj	težina [g]	pakiranje [kom]
KN D01	002231003	E 14	14	20/500
KN D02	002232003	E 18	17	20/500

**Kapa D0 - plastična**

tip	šifra	navoj	težina [g]	pakiranje [kom]
PLK D01	002231008	E 14	9	10/500
PLK D02	002232008	E 18	11	10/500

**Specijalni držač****Specijalni držač**

šifra	težina [g]	pakiranje [kom]
002231000	1	25/300

**Osiguračke rastavne jedinice****Sklopka - osigurač - rastavljač VLD01**

Nazivna struja  
**2 - 6, 10, 16 A**

Kategorija upotrebe  
**AC22**

Sklopka - osigurač - rastavljač VLD01 je zaštitni aparat sa zamjenljivim sistemom ladica.

Prednosti i navažnije karakteristike:

























- zamjena rastalnog uloška bez opasnosti direktnog dodira dijelova pod naponom pomoću izvlačive ladice
- uključivanje aparata bez vijčanog spajanja – kontakt se uspostavlja automatski pomoću opruge
- potpuna zaštita od direktnog dodira prema VBG4
- u položaju 1 i 0 indikator djelovanja rastalnog uloška vidljiv je kroz prozirni prozorčić.

## Keramičke osnove osigurača

### Tehnički podaci

Nazivni napon $U_n$	400 V AC
Nazivna struja $I_n$	D01 16 A, D02 63 A
Presjek priključnih vodiča	D01 1 - 4 mm <sup>2</sup> D02 1,5 - 25 mm <sup>2</sup>
Priključne stezaljke	sa vijkom +- PZ
Standard	IEC 60269, EN 60269, DIN VDE 0636, SIST EN 60269

### 1-polne osnove D0

tip	priključci		presjek priključnih vodiča [mm <sup>2</sup> ]	dimenzije A [mm]
	odvod	dovod		
D01N - K	 M4	 M4	1,5 - 4	53
D01V - K	 M4	 M4	1,5 - 4	53
D02N - K	 2xM5	 2xM5	2,5 - 25	57
D02V - K	 2xM5	 2xM5	2,5 - 25	57
D02N M5 - K	 2xM5	 M5	2,5 - 25	57
D02V M5 - K	 2xM5	 M5	2,5 - 25	57
D01N	 M4	 M4	1,5 - 4	53
D01V	 M4	 M4	1,5 - 4	53
D02N	 2xM5	 2xM5	2,5 - 25	57
D02V	 2xM5	 2xM5	2,5 - 25	57
D02N M5	 2xM5	 M5	2,5 - 25	57
D02V M5	 2xM5	 M5	2,5 - 25	57

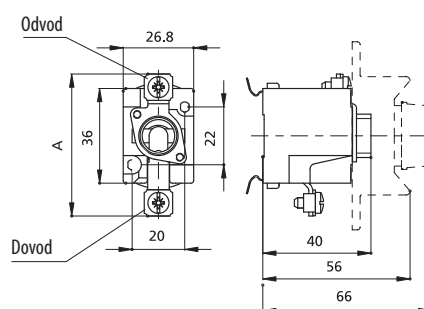





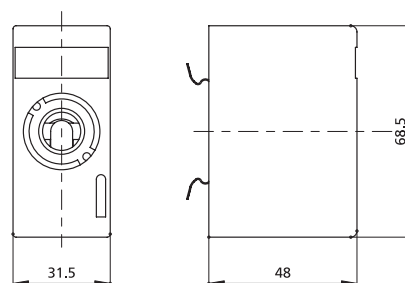



















### 1-polne osnove D0 - U

tip	priključci		presjek priključnih vodiča [mm <sup>2</sup> ]
	odvod	dovod	
D01 U	 M4	 M4	1,5 - 4
D02 U	 2xM5	 2xM5	2,5 - 25



### 3-polne osnove D0

tip	priključci		presjek priključnih vodiča [mm <sup>2</sup> ]	dimenzije A [mm]
	odvod	dovod		
D01N/3 - K	 M4	 M4	1,5 - 4	53
D01V/3 - K	 M4	 M4	1,5 - 4	53
D02N/3 - K	 2xM5	 2xM5	2,5 - 25	57
D02V/3 - K	 2xM5	 2xM5	2,5 - 25	57
D02N/3 M5 - K	 2xM5	 M5	2,5 - 25	57
D02V/3 M5 - K	 2xM5	 M5	2,5 - 25	57
D01N/3	 M4	 M4	1,5 - 4	53
D01V/3	 M4	 M4	1,5 - 4	53
D02N/3	 2xM5	 2xM5	2,5 - 25	57
D02V/3	 2xM5	 2xM5	2,5 - 25	57
D02N/3 M5	 2xM5	 M5	2,5 - 25	57
D02V/3 M5	 2xM5	 M5	2,5 - 25	57

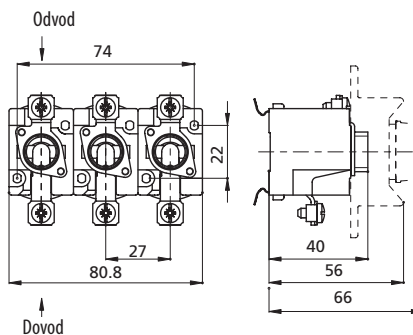

## Tehnički podaci

### Plastične osnove osigurača PPD01 i PPD02

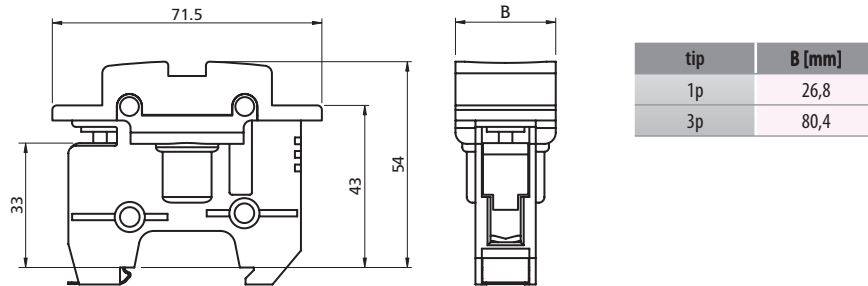

### Zaštitni poklopci

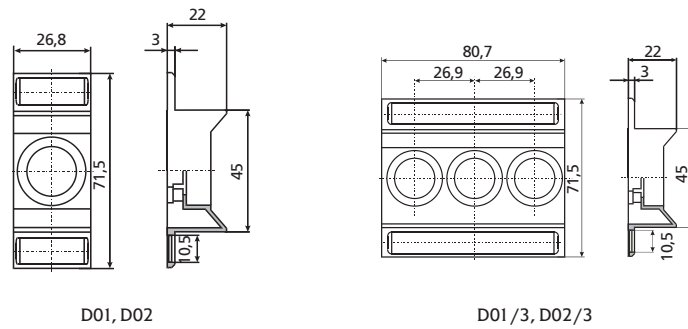

### Kalibarski prstenovi

#### V D01 za osnovu E 14

$I_n$ [A]	dimenzije	
	$\varnothing A$	$\varnothing B$
2	7,9	12
4	7,9	12
6	7,9	12
10	9,1	12

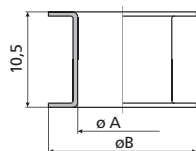

#### V D02 za osnovu E 18

$I_n$ [A]	dimenzije	
	$\varnothing A$	$\varnothing B$
2*	7,9	16,6
4*	7,9	16,6
6*	7,9	16,6
10*	9,1	16,6
16*	10,3	16,6
20	11,5	16,6
25	12,7	16,6
35	13,9	16,6
50	15,1	16,6

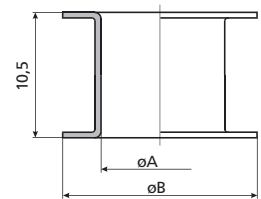

\*Za upotrebu rastalnih uložaka D01 i osnova osigurača D02.

### Kape D0

